

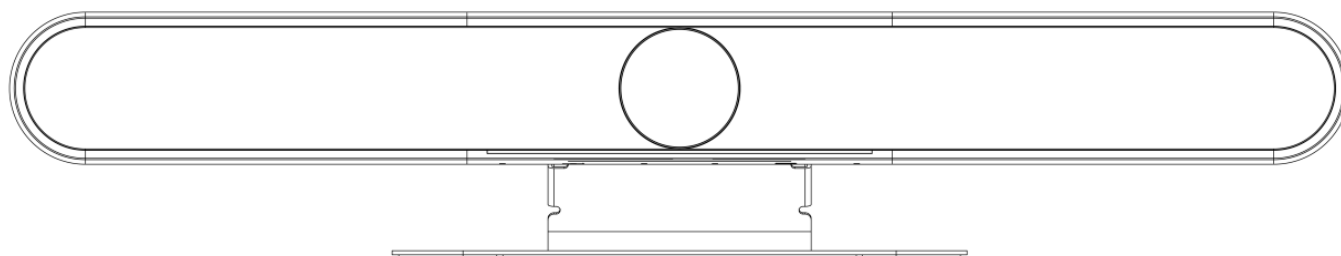

Argos VSB-1 VideoSoundbar

Video Soundbar med USB3.0 | Bluetooth



User Manual

(V1.0)

Preface



This manual is to ensure that the user can use the product properly and avoid danger while operating. Before using this product, please read the user manual carefully and keep it properly for future reference

Overview:

This manual describes the operation of Intelligent 4K All-in-one Video Bar.

Graphic Symbols

Description of graphic symbols used in this manual

Symbols	Description
	This symbol indicates that the words are clarification or supplement to this article.
	This symbol indicates that negligence of the instructions may lead to mishandling that may cause injury or property damage.
	This symbol indicates a risk that may result in damage to this machine or documents. Follow the instructions to avoid property damage.

Attention

This manual introduces functions, installations and operations for this product in details. Please read this manual carefully before installation and use.

Precautions:

This product can only be used in the specified conditions in order to avoid any damage to the camera:

- 1) Do not expose the product to rain or moisture.
- 2) To prevent the risk of electric shock, do not open the case. Installation and maintenance should only be carried out by qualified technicians.
- 3) Do not use the product beyond the specified temperature, humidity or power supply specifications.
- 4) Please use a soft dry cloth to clean the camera. If the camera is very dirty, clean it with diluted neutral detergent; do not use any type of solvents, which may damage the surface.

Electrical Safety:

Installation and use of this product must strictly comply with local electrical safety standards.

Transportation:

Avoid any stress, vibration, or moisture during transportation, storage, installation and operation

Installation:

- 1) Do not rotate the camera head violently, otherwise it may cause mechanical failure;
- 2) This product should be placed on a stable desktop or other horizontal surface. Do not install the product obliquely, otherwise it may display inclined image;
- 3) Ensure there are no obstacles within rotation range of the holder.
- 4) Do not power on before completely installation.

Do Not Dismantle Camera :

We are not responsible for any unauthorized modification or dismantling.

Magnetic Interference

Electromagnetic fields at specific frequencies may affect the video image. This product is Class A. It may cause radio interference in household application. Appropriate measure is required.

Contents

1.	Quick Start	4
	1.1 Interfaces	4
	1.2 Device Startup	4
	1.2.1 Power on.....	4
	1.2.2 Statue Indicator Light.....	4
	1.3 Video Output	5
	1.4 Audio Input	5
	1.5 Audio Output	5
2.	Product Overview.....	6
	2.1 Product Introduction	6
	2.1.1 Dimension.....	6
	2.1.2 Supplied Accessory.....	6
	2.2 Product Features	7
	2.3 Technical Specification.....	9
3.	How to Use.....	13
	3.1 Remote Control	13
	3.2 Menu Setting	14
	3.2.1 Main Menu.....	14
4.	Maintenance and Troubleshooting	21
	4.1 Maintenance	21
	4.2 Troubleshooting.....	21

1. Quick Start

1.1 Interfaces

Interfaces	
USB	USB audio video in out, type C
HDMI	HDMI video output
LINE IN	Audio linear input
LINE OUT	3.5mm linear output
Extension Mic	RJ45 extension mic
Power jacket	HEC3800 power socket(DC12V), input AC110V-AC220V, output DC12V/2A

1.2 Device Startup

1.2.1 Power on

Connect device to power socket with DC12V power adapter.

1.2.2 Statue Indicator Light

Green lights continuously run left to right	Boot initialization in progress
Blinking Blue Lights	In Bluetooth pairing mode
Lights Turn Blue and Stay 3S	Bluetooth pairing finished
Solid Green Light	Working statue : When turn off Auto-framing&Voice tracking, all light turn green When turn on Auto-framing&Voice tracking, partial light turn green
Blinking Green Light	Standby statue(Device on without video)
Solid Red Light	Microphone Muted
Green Indicator Light On/Off	Volume up/down
Partial Light Turn Green	Partial light turns green according to the voice source

1.3 Video Output

1. USB: Connect device to Pcs through USB cable, and open the video software to select device to output.
2. HDMI: Connect device to monitor through HDMI cable, and then select the correct input source on the monitor to output.

1.4 Audio Input

1. Built-in audio: It is default that the device pick up voice through built-in mics
2. Audio input through 3.5mm linear audio cable: Connect to external pickup through 3.5mm audio cable (When connecting to external pickup, audio in automatically switch into external pickup.)

1.5 Audio Output

1. Built-in speaker: It is default that device output voice through built-in speaker.
2. Audio output through 3.5mm linear audio cable: Connect to external speaker through 3.5mm audio cable (When connecting to external speaker, audio out automatically switch into external speaker.)

2. Product Overview

2.1 Product Introduction

2.1.1 Dimension

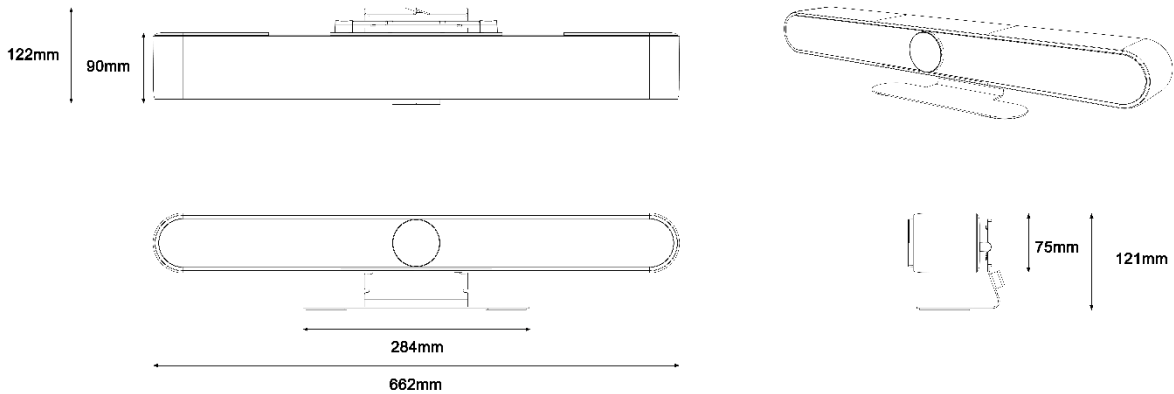

2-1 Dimension

2.1.2 Supplied Accessory

When you unpack your box, please check that all the supplied accessories are included.

Items	Quantity	selection
All-in-one video bar	1	Supplied
USB cable	1	
Remote control(No battery included)	1	
Quick start guide	1	
Power adapter	1	

2.2 Product Features

With all-in-one design, this device has 4K UHD camera, microphone array, high fidelity speaker and electric privacy cover. Boasting powerful functions like face recognition, voice localization, voice tracking, and intelligent noise reduction, this product could automatically adjust the image size according to the number of participants to present the optimal frame. It can also detect the speaker position in real time and lock the target while having a close-up, which allows users to have hands-free operation. This device has 6 array microphone for speaker tracking, 2 electret microphones for pickup.

- **Integrated Design:** Built in 4K UHD camera, microphone array, high fidelity speaker and electric privacy cover
- **Ultra HD:** This device adopts 8 M high quality CMOS image sensor, able to capture 4K ultra HD image to present true-to-life image, bringing excellent image resolution and clarity.
- **Distortion-less Wide Angle Lens:** 115° wide angle with no distortion lens allows every participant is on the frame with no need to adjust the camera.
- **Automatic Privacy Cover:** Privacy cover will automatically close to ensure the privacy security.
- **Microphone Array:** Built in 6 array microphone enable speaker can be tracked in real time. THIS DEVICE break the distance limitation to provide virtual meeting as if you are there.
- **Built in Speaker:** Built in dual 10W high quality studio speaker, ensuring every participant can hear and be heard clearly.
- **Audio Processing:** The audio processing algorithm adopts high-fidelity 48K audio sampling rate, lossless audio transmission technology, supports AEC, AGC, ANS processing, bringing high-quality calls of 6 meters full duplex;
- **Auto Framing:** Built in face detection algorithm, automatically detect participant and provide optimal framing.
- **Bluetooth 5.0:** Connect mobile phone and other devices through Bluetooth to be used as Bluetooth speaker and microphone.

- **Low Noise and High SNR:** Low noise CMOS ensure the ultra SNR of image. The advanced 2D, 3D noise reduction technology further reduce the noise while ensuring the image clarity.
- **Powerful Compatibility:** Compatible with Windows7, windows10, Mac OS 10.10 or higher system, applicable to major cloud-based video conference platforms.

2.3 Technical Specification

Camera	Lens	FOV	115°(D)/106°(H)/72°(V)
		Iris	F2.0
		Focal Length	1.89mm
		Digital Zoom	10X
	Sensor	High quality CMOS sensor, effective pixel 8 million, 16:9	
	Image	Minimum Illumination	0.5Lux
		DNR	2D & 3D
		Focus	Fixed focus
		BLC	On/Off
		Exposure	Parameter can be adjusted, and AE(Auto Exposure) is available
		Video Adjustment	Brightness, sharpness, saturation, contrast, white balance, gain, anti-flicker, low brightness compensation and other parameters can be adjusted
		SNR	≥50dB
	Video Format	HDMI: 4KP30,1080P60 compatible downward USB: 4KP30,1080P60 compatible downward	
Video Compression Format	MJPEG, YUY2, H.264, H.265, NV12		

	Privacy Cover	Automatic privacy cover will close when no image output and open when there are image output.		
Audio	Microphone	Microphone	6 x MENS Microphones + 2 x electret microphones	
		Pickup Distance	6 meters	
		Frequency Response	120 Hz–16 kHz	
	Speaker	Speaker	Built in dual speaker	
		Voltage	2*10W	
		Output Voice Pressure	80±3 dB 1.0M/1.0W	
		Frequency Response	100 Hz-20 KHz	
Audio Processing	AEC, AGC, ANS			
AI Function	Group Framing	Automatically adjust the screen size according to the number of participants to present the best framing		
	Speaker Tracking	Track each speaker in real time, and ensure that the speaker is in the center of the screen.		
Remote Control	Remote Control	Infrared remote control (No battery included)		
Physical Interfaces	USB	USB3.0 audio video output interface , Type C Support UVC1.1, UAC1.0 and higher		

	HDMI	HDMI video output interface HDMI also compatible with HDMI2.0 standard
	LINE IN	3.5mm audio line input interface (when an external pickup is connected, the audio input is automatically switched to the external pickup)
	LINE OUT	3.5mm line output, can be connected to external speakers (when connecting to external speakers, the audio output will automatically switch to external speakers)
	Expansion Mic Interface	RJ45 interface, able to connect to expansion microphone.
	Power Interface	HEC3800 power socket (DC12V), input AC110V-AC220V output DC12V/2.5A
Indicator	Bar-shaped Indicator	While displaying the working status, it can also be lit where the speaker's voice comes from.
Bluetooth	Bluetooth 5.0	Can be connected to a mobile phone or other device via Bluetooth as a Bluetooth microphone and speaker
Compatibility	Available System	Windows 7, Windows 8, Windows 10, Mac OS X, Linux, Android
Power Supply Method		Supply power through power adapter
Working Condition	Storage Temperature	-10°C ~ +70°C
	Storage Humidity	20% ~ 95%
	Working Temperature	-10°C ~ +50°C

	Working Humidity	20% ~ 80%
	Environment	Indoor
Installation Method	Walling Mount	Comes with walling mount bracket. While mounting, the camera need to be as close to the wall as possible.
	Desktop	Comes with desktop mounting bracket
	Installed on Monitor	Bracket for monitor installation(optional)

3. How to Use

3.1 Remote Control

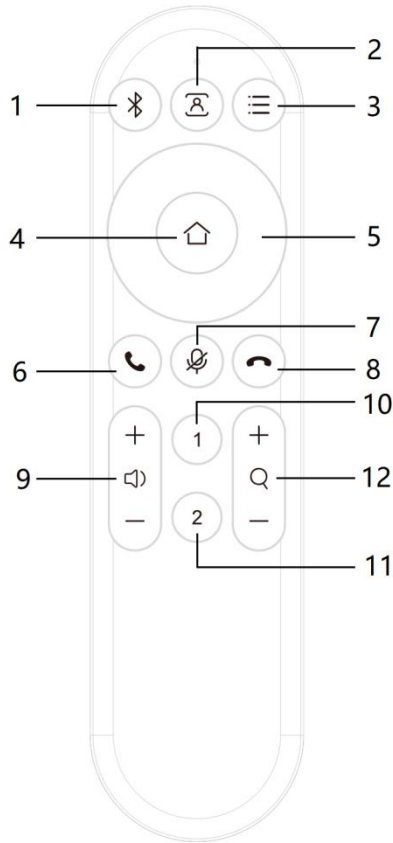

Number	Function Description	Detailed Description
1	Bluetooth	<p>1. Pairing mode: Hold the Bluetooth button for 3S, then the blue light is flashing;</p> <p>2. Pairing is successful: If the connection with the mobile phone/laptop is successful, the light shift from flashing blue into solid green.</p> <p>3. Disconnect: In the Bluetooth connection state, hold the Bluetooth button for 5S to disconnect from the paired device</p> <p>Note: Bluetooth will be automatically turned off if no device is connected after 30s</p>
2	Auto Framing	Click the button, the upper left corner of the image will prompt "Auto Frame: ON" or "Auto Frame:

		OFF"
3	Menu	Click the menu button to enter the submenu for function setting and modification
4	HOME	1. The "HOME button" in the menu is used for function confirmation, setting and modification. 2. Sleep state: "HOME button" to wake up the device; 3. After manual zooming, pressing the "HOME button" will restore the image to its original position;
5	Up, down, left, right	Click the directional buttons to adjust the position
6	Answer call	If the device is in Bluetooth mode, click the button to answer the incoming call.
7	Microphone muted	When the device is connected to Bluetooth and an incoming call is on the way, click the button to mute the microphone, then the device indicator light turns red. Click the button again to unmute
8	Reject the incoming call	When the device is connected to Bluetooth, click the button to reject the incoming call
9	Volume up/down	Click the button to adjust the speaker volume
10	Set/call out preset #1	Press and hold 3 seconds to set preset and short press it to call out the preset
11	Set/call out preset #2	Press and hold 3 seconds to set preset and short press it to call out the preset
12	Zoom in/out	Click the button to zoom in/out the image.

3.2 Menu Setting

3.2.1 Main Menu

Press menu key on remote control, and use arrow to point item to be selected.

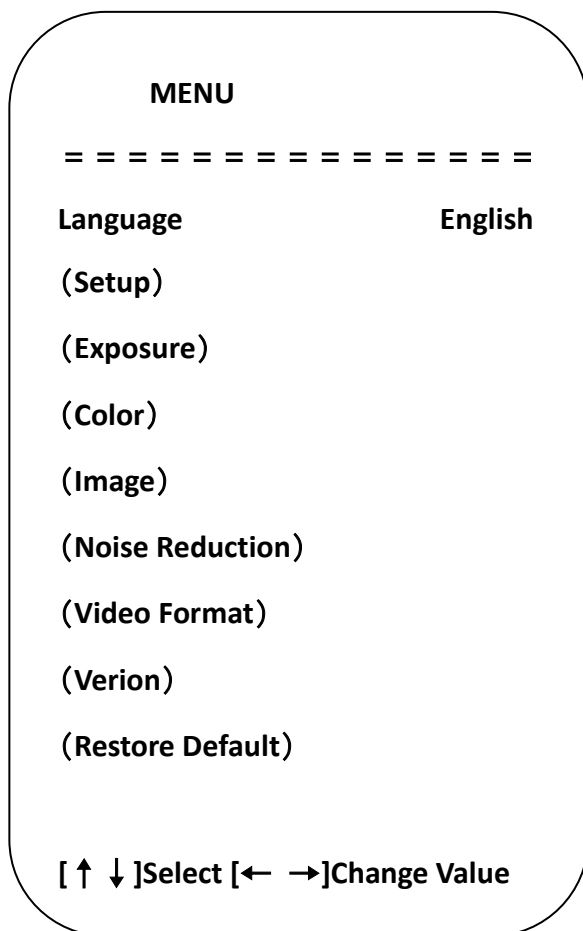

1) Language

Move arrow to (Language), and press **【← →】** to change the option

2) Setting

Move arrow to (Setting), and press **【HOME】** to enter the exposure interface.

Setup	
=====	
Image Style	Default
Auto Framing	Close
Auto Framing Sen	Medium
Voice Location	Close
Locatiom Sen	Medium
Max Framing	5X
Locate Mode	Smart Mode
Prompt Info	Close
Menu Mirror	Close
Transfers Mode	BULK

[↑ ↓]Select [← →]Change Value

Image Style: Default/standard/clear/bright/soft

Auto Framing: On/off

Auto Framing Sen: high/medium/low

Max Framing: 3X/5X/10X

Voice Tracking: on/off

Voice Tracking Sen: high/medium/low

Locate Mode: Smart mode/pan mode/movie mode/discussion mode

Prompt Info: On/off

Menu Mirror: On/off

Transfers Mode: Bulk/synchronization

3) Exposure

Move arrow to (exposure), press **【HOME】** to enter exposure interface.

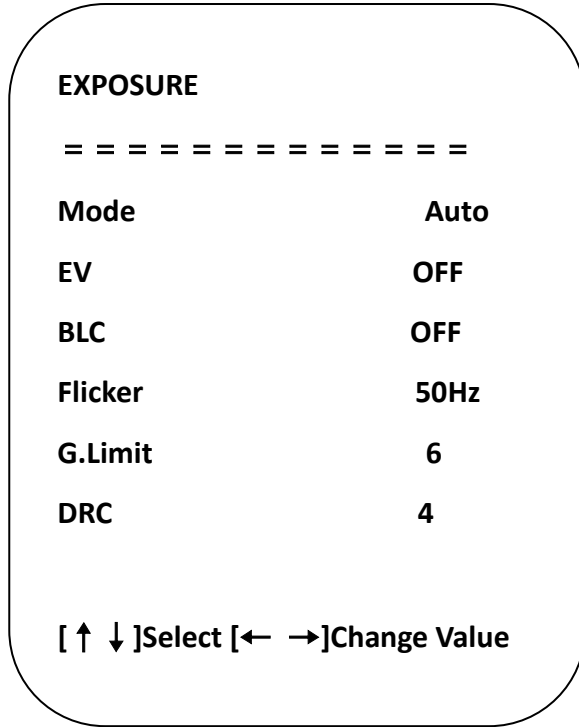

Exposure mode: Auto/manual/shutter priority/bright priority

Exposure Compensation(EV): On/off

Compensation Level: -7 – 7(only available in EV mode on)

BLC: On/off (only available in auto mode)

Anti-Flicker: 50Hz, 60Hz, off (only available in auto, iris priority, bright priority mode)

Gain Limit: 0 – 15(only available in auto, iris priority, bright priority mode)

Dynamic Range: 1 – 8, off

Shutter Priority: 1/30, 1/50, 1/60, 1/90, 1/100, 1/120, 1/180, 1/250, 1/350, 1/500, 1/1000, 1/2000, 1/3000, 1/4000, 1/6000, 1/10000(only available in manual, and shutter priority mode)

Bright: 0 – 23 (only available in bright priority)

4) Color

Move arrow to (color), and press **【HOME】** to enter color page.

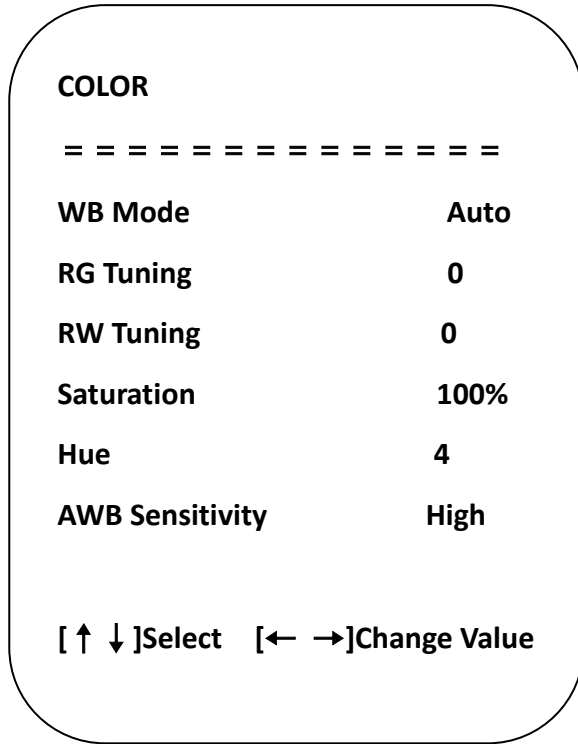

WB Mode: Auto/manual/one-push/specified temperature

Saturation: 0~127

RG Tuning: -10~10

Blue Tuning: -10~10

AWB Sensitivity: High/medium/low(only available in auto mode)

Hue: 0~8

5) Image

Move arrow to (image), and press **【HOME】** to enter image page.

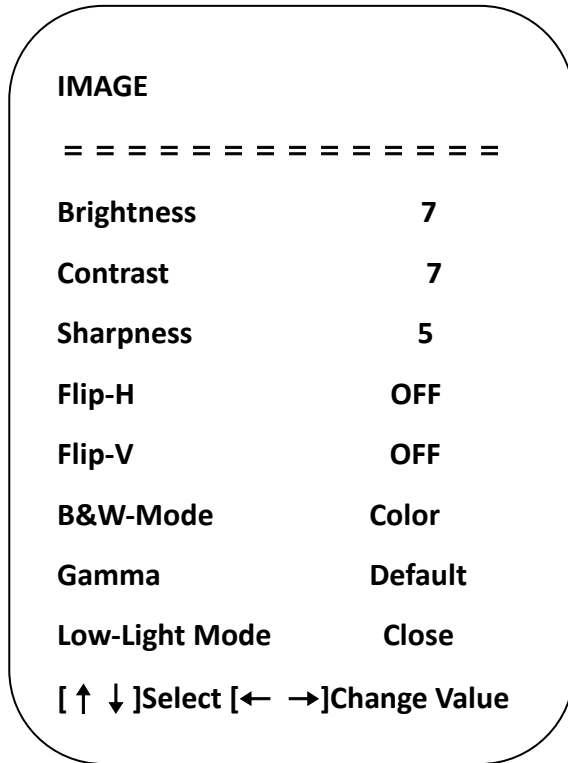

Brightness: 0~14

Contrast: 0~14

Sharpness: 0~15

Flip-H: On/off

Flip-V: On/off

B&W-Mode: Color/B&W

Gamma: Default, 0.34,
0.39, 0.47, 0.50

Low-Light Mode: On/off

6) Noise Reduction

Move arrow to (Noise Reduction), and press **【HOME】** to enter Noise Reduction page.

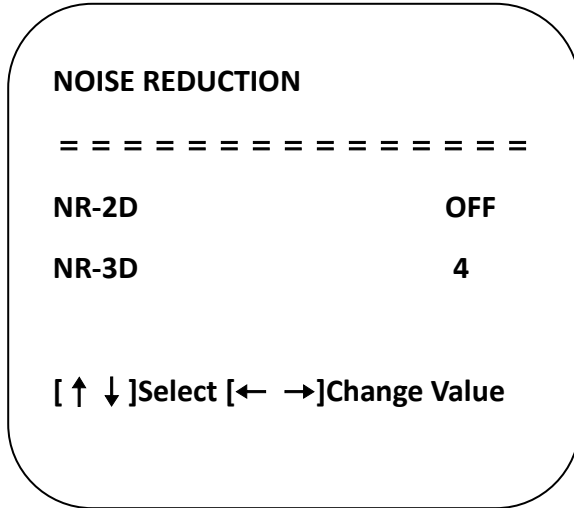

2D NR: Auto, manual 1~7

3DNR: Off, 1~8

7) Version

Move arrow to (version)

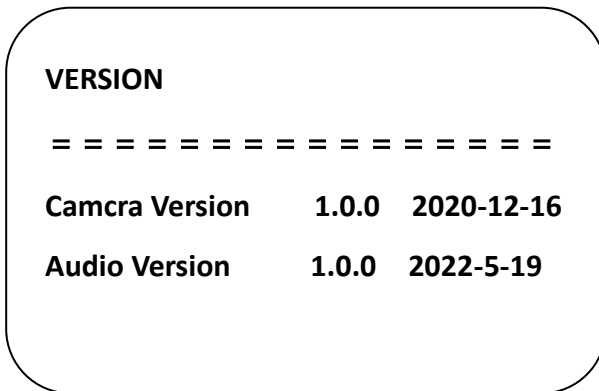

8) Restore Default

Move arrow to (restore default), and press **【HOME】** to enter RESTORE DEFAULT page.

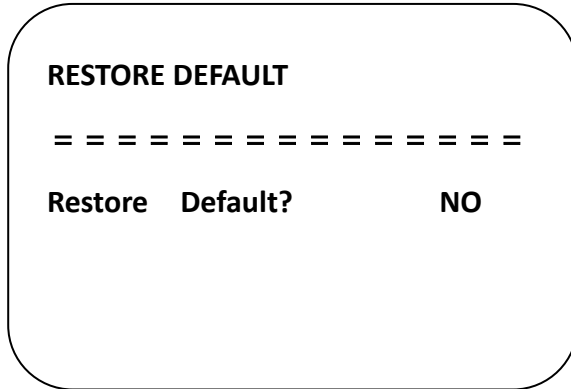

Restore default: Yes/no (color style and video format cannot be restored)

4. Maintenance and Troubleshooting

4.1 Maintenance

- 1) If the camera will not be used for a long time, please turn off the power switch.
- 2) Use a soft cloth or lotion-free tissue to clean the camera body.
- 3) Use a soft dry lint-free cloth to clean the lens. If the camera is very dirty, clean it with a diluted neutral detergent. Do not use any type of solvent or harsh detergent, which may damage the surface.

4.2 Troubleshooting

1) No image

- a. Check whether the power cord is connected, voltage is OK, POWER lamp is lit.
- b. Check whether the camera can “self-test” after startup
- c. Check that the rotary dial on rear work normally
- d. Check that the HDMI cable is connected correctly

2) Image is shaky or vibrating.

Check that the video output, video monitor cable work normally.

3) Remote controller does not control the camera

- a. Check that the batter of remote control is placed properly and full of power
- b. Check that the working statue of the device is normal

c. Check whether the menu has been exited. Only after exiting the menu, the remote control can work normally; if the webpage outputs an image, the menu will not be displayed, then the menu will automatically exit and remote control can work on camera after 30 seconds without any operation